

# ZK830



## User Instructions

**Avery Weigh-Tronix is a trademark of the Illinois Tool Works group of companies whose ultimate parent company is Illinois Tool Works Inc (“Illinois Tool Works”). Copyright © 2017 Illinois Tool Works. All rights reserved.**

No part of this publication may be reproduced by making a facsimile copy, by the making of a copy in three dimensions of a two-dimensional work and the making of a copy in two dimensions of a three-dimensional work, stored in any medium by electronic means, or transmitted in any form or by any means, including electronic, mechanical, broadcasting, recording or otherwise without the prior written consent of the copyright owner, under license, or as permitted by law.

This publication was correct at the time of going to print, however Avery Weigh-Tronix reserves the right to alter without notice the specification, design, price or conditions of supply of any product or service at any time.

# Table of Contents

	<i>page</i>
<b>Table of Contents</b> .....	3
<b>Chapter 1 General information and warnings</b> .....	5
About this manual .....	5
Text conventions .....	5
Special messages .....	5
Installation .....	6
Safe handling of equipment with batteries .....	6
Wet conditions .....	6
Routine maintenance .....	7
Cleaning the machine .....	7
Training .....	7
Sharp objects .....	7
FCC and EMC declarations of compliance .....	8
Declaration of Conformity .....	9
<b>Chapter 2 Introduction</b> .....	10
Basic counting principles .....	10
Front panel .....	11
Annunciators .....	12
Powering up the ZK830 .....	12
Connections on the BSQ .....	13
Leveling the scale .....	15
Numeric entry procedure (without optional keypad) .....	16
Numeric entry procedure (with optional keypad) .....	16
Printing .....	16
<b>Chapter 3 Indicator applications</b> .....	17
First time power up .....	17
Counting application .....	17
Sampling methods .....	17
Remote base switching (optional keypad required) .....	18
Entering known tare weights and piece weights (optional keypad required) .....	18
SELECT key default function .....	18
Special key functions .....	19
Sample size .....	19
Counting in dribble mode .....	19
Counting in bulk mode .....	20
Using PLUs (optional keypad only) .....	21
Check counting .....	22
General weighing application .....	23
SELECT key default function .....	23
Gross weighing .....	23
Net weighing .....	23
High resolution weighing (if enabled) .....	25
Percentage weighing .....	25
Using setpoints .....	25
Printing .....	26
Checkweighing application .....	27
SELECT key default function .....	27
Special key functions .....	27
Checkweighing operation .....	27

Weighing a target object .....	28
Checkweighing using PLUs (with optional keypad only) .....	28
Accumulating gross and net weights .....	29
<b>Chapter 4 Menus .....</b>	<b>30</b>
Accessing the menus .....	30
Menu annunciators .....	30
Exiting the menus .....	31
USER level menus .....	31
User menu .....	32
Time .....	32
About menu .....	34
Audit menu .....	35
<b>Chapter 5 Error messages .....</b>	<b>36</b>
<b>Chapter 6 String index/character data entry .....</b>	<b>37</b>
<b>Chapter 7 Options .....</b>	<b>38</b>
Remote keypad .....	38
Light stack .....	38
Debris shield .....	39
Desk/wall mount .....	39
Columns .....	40
Draft shield .....	40
Underhook .....	41
Ball top .....	41
Batteries .....	42
Clamp down plate .....	42
802 wireless option card .....	43
Remote base analog card .....	43
Printer .....	44
Scanner .....	44
<b>Chapter 8 Supervisor menu .....</b>	<b>45</b>
General Weighing application supervisor menu .....	46
Setpoint menu item .....	47
Battery menu item .....	47
PLU menu item .....	48
Totals menu item .....	48
App Pwr menu item .....	48
Counting application supervisor menu .....	49
Count menu item .....	50
PLU menu item .....	51
Checkweighing application supervisor menu .....	53
Check menu item .....	53

# 1 General information and warnings

## 1.1 About this manual

---

This manual is divided into chapters by the chapter number and the large text at the top of a page. Subsections are labeled as shown by the 1.1 and 1.1.1 headings. The names of the chapter and the next subsection level appear at the top of alternating pages of the manual to remind you of where you are in the manual. The manual name and page numbers appear at the bottom of the pages.

### 1.1.1 Text conventions

---

Key names are shown in **bold** and reflect the case of the key being described. If a key has a dual function it may be referred to by its alternate function.

Displayed messages appear in ***bold italic*** type and reflect the case of the displayed message.

Annunciator names appear as *italic* text.

### 1.1.2 Special messages

---

Examples of special messages you will see in this manual are defined below. The signal words have specific meanings to alert you to additional information or the relative level of hazard.



---

**CAUTION!**

***This is a Caution symbol.***

***Cautions give information about procedures that, if not observed, could result in damage to equipment or corruption to and loss of data.***

---



---

***NOTE: This is a Note symbol. Notes give additional and important information, hints and tips that help you to use your product.***

---

## 1.2 Installation

---



---

**NO USER SERVICEABLE PARTS. REFER TO QUALIFIED SERVICE PERSONNEL FOR SERVICE.**

---



---

*Equipment to be powered by a UL Listed I.T.E. power supply: rated 12 -36VDC and marked "LPS", or a UL Listed power supply rated 12-36VDC and marked "Class 2."*

---



---

*The Socket-Outlet shall be installed near the equipment and shall be easily accessible.*

---

### 1.2.1 Safe handling of equipment with batteries

---



---

**CAUTION: Danger of explosion if battery is incorrectly replaced. Replace only with the same or equivalent type recommended by the manufacturer. Dispose of used batteries according to the manufacturer's instructions.**

---

---

**ATTENTION: Il y a danger d'explosion s'il y a remplacement incorrect de la batterie, remplacer uniquement avec une batterie du même type ou d'un type équivalent recommandé par le constructeur. Mettre au rebut les batteries usagées conformément aux instructions du fabricant.**

---

### 1.2.2 Wet conditions

---

Under wet conditions, the plug must be connected to the final branch circuit via an appropriate socket / receptacle designed for washdown use.

**Installations within the USA** should use a cover that meets NEMA 3R specifications as required by the National Electrical Code under section 410-57. This allows the unit to be plugged in with a rain tight cover fitted over the plug.

**Installations within Europe** must use a socket which provides a minimum of IP56 protection to the plug / cable assembly. Care must be taken to make sure that the degree of protection provided by the socket is suitable for the environment.

## 1.3 Routine maintenance

---



**IMPORTANT:** This equipment must be routinely checked for proper operation and calibration.  
Application and usage will determine the frequency of calibration required for safe operation.

---

Always isolate the indicator from the power supply before starting any routine maintenance to avoid the possibility of electric shock.

## 1.4 Cleaning the machine

---

Table 1.1 Cleaning DOs and DON'Ts



DO	DO NOT
Wipe down the outside of standard products with a clean cloth, moistened with water and a small amount of mild detergent	Attempt to clean the inside of the machine
	Use harsh abrasives, solvents, scouring cleaners or alkaline cleaning solutions
Spray the cloth when using a proprietary cleaning fluid	Spray any liquid directly on to the display windows

## 1.5 Training

---

Do not attempt to operate or complete any procedure on a machine unless you have received the appropriate training or read the instruction books.

To avoid the risk of RSI (Repetitive Strain Injury), place the machine on a surface which is ergonomically satisfactory to the user. Take frequent breaks during prolonged usage.

## 1.6 Sharp objects

---

Do not use sharp objects such as screwdrivers or long fingernails to operate the keys.

## 1.7 FCC and EMC declarations of compliance

---

### United States

---

This equipment has been tested and found to comply with the limits for a Class A digital device, pursuant to Part 15 of the FCC Rules. These limits are designed to provide reasonable protection against harmful interference when the equipment is operated in a commercial environment. This equipment generates, uses, and can radiate radio frequency energy and, if not installed and used in accordance with the instruction manual, may cause harmful interference to radio communications. Operation of this equipment in a residential area is likely to cause harmful interference in which case the user will be required to correct the interference at his own expense.

### Canada

---

This digital apparatus does not exceed the Class A limits for radio noise emissions from digital apparatus set out in the Radio Interference Regulations of the Canadian Department of Communications.

Le présent appareil numérique n'émet pas de bruits radioélectriques dépassant les limites applicables aux appareils numériques de la Classe A prescrites dans le Règlement sur le brouillage radioélectrique édicté par le ministère des Communications du Canada.

### European Countries

---

**WARNING:** This is a Class A product. In a domestic environment, this product may cause radio interference in which the user may be required to take adequate measures.



# 1.8 Declaration of Conformity



<b>EU</b> <b>Declaration of Conformity</b>	<p><b>Model / Type: ZK830</b></p> <p>Name and address of the manufacturer: Avery Weigh-Tronix® Foundry Lane Surrey Wick Woking, Surrey WIMBORNE B66 2LP ENGLAND</p> <p>The declaration of conformity is issued under the sole responsibility of the manufacturer.</p> <p>Objet de la déclaration: ZK830 ZK830-PK0 ZK830 + ISO-XY-CCC* ZK830 + ZK830-PK0 + ISO-XY-CCC* 1XXY-991214, CCC-06893898</p> <p>The object of the declaration described above is in conformity with the relevant Union harmonisation legislation.</p> <p>Applicable Directives: Harmonised standards or other technical specifications</p>
<b>EN</b>	<p><b>Model / Type: ZK830</b></p> <p>Name and address of the manufacturer: Avery Weigh-Tronix® Foundry Lane Surrey Wick Woking, Surrey WIMBORNE B66 2LP ENGLAND</p> <p>This declaration of conformity is issued under the sole responsibility of the manufacturer.</p> <p>Objet de la déclaration: ZK830 ZK830-PK0 ZK830 + ISO-XY-CCC* ZK830 + ZK830-PK0 + ISO-XY-CCC* 1XXY-991214, CCC-06893898</p> <p>L'objet de la déclaration décrite ci-dessus est conforme à la législation de l'Union relative à la certification.</p> <p>Directives applicables: Normes harmonisées ou autres spécifications techniques</p>

<b>EU</b> <b>Konformitätserklärung</b>	<p><b>Modell / Typen: ZK830</b></p> <p>Name und Anschrift des Herstellers: Avery Weigh-Tronix® Foundry Lane Surrey Wick Woking, Surrey WIMBORNE B66 2LP ENGLAND</p> <p>Die alleinige Verantwortung für die Ausstellung dieser Konformitätserklärung liegt bei Hersteller.</p> <p>Objekt der Erklärung: ZK830 ZK830-PK0 ZK830 + ISO-XY-CCC* ZK830 + ZK830-PK0 + ISO-XY-CCC* 1XXY-991214, CCC-06893898</p> <p>Der oben beschriebene Gegenstand der Erklärung erfüllt die einschlägigen Harmonisierungsrichtlinien der Union.</p> <p>Anzuwendende Richtlinien: Harmonisierte Standards oder andere technische Spezifikationen</p>
<b>DE</b>	<p><b>Modell / Typen: ZK830</b></p> <p>Name und Anschrift des Herstellers: Avery Weigh-Tronix® Foundry Lane Surrey Wick Woking, Surrey WIMBORNE B66 2LP ENGLAND</p> <p>Die alleinige Verantwortung für die Ausstellung dieser Konformitätserklärung liegt bei Hersteller.</p> <p>Objekt der Erklärung: ZK830 ZK830-PK0 ZK830 + ISO-XY-CCC* ZK830 + ZK830-PK0 + ISO-XY-CCC* 1XXY-991214, CCC-06893898</p> <p>L'objet de la déclaration décrite ci-dessus est conforme à la législation de l'Union relative à la certification.</p> <p>Directives applicables: Normes harmonisées ou autres spécifications techniques</p>

<b>FR</b> <b>Déclaration UE de conformité</b>	<p><b>Modèle / Type: ZK830</b></p> <p>Nom et adresse du fabricant: Avery Weigh-Tronix® Foundry Lane Surrey Wick Woking, Surrey WIMBORNE B66 2LP ENGLAND</p> <p>La présente déclaration de conformité est établie sous la seule responsabilité du fabricant.</p> <p>Objet de la déclaration: ZK830 ZK830-PK0 ZK830 + ISO-XY-CCC* ZK830 + ZK830-PK0 + ISO-XY-CCC* 1XXY-991214, CCC-06893898</p> <p>L'objet de la déclaration décrit ci-dessus est conforme à la législation de l'Union applicable.</p> <p>Les normes et directives applicables: Normes harmonisées ou autres spécifications techniques</p>
<b>FR</b>	<p><b>Modèle / Type: ZK830</b></p> <p>Nom et adresse du fabricant: Avery Weigh-Tronix® Foundry Lane Surrey Wick Woking, Surrey WIMBORNE B66 2LP ENGLAND</p> <p>La présente déclaration de conformité est établie sous la seule responsabilité du fabricant.</p> <p>Objet de la déclaration: ZK830 ZK830-PK0 ZK830 + ISO-XY-CCC* ZK830 + ZK830-PK0 + ISO-XY-CCC* 1XXY-991214, CCC-06893898</p> <p>L'objet de la déclaration décrit ci-dessus est conforme à la législation de l'Union applicable.</p> <p>Les normes et directives applicables: Normes harmonisées ou autres spécifications techniques</p>

<b>NL</b> <b>Conformiteitsverklaring</b>	<p><b>Model / Type: ZK830</b></p> <p>Naam en adres van de fabrikant: Avery Weigh-Tronix® Foundry Lane Surrey Wick Woking, Surrey WIMBORNE B66 2LP ENGLAND</p> <p>Dit is een conformiteitsverklaring voor het verspreiden onder volgorde verantwoordelijkheid van de fabrikant.</p> <p>Objekt van de verklaring: ZK830 ZK830-PK0 ZK830 + ISO-XY-CCC* ZK830 + ZK830-PK0 + ISO-XY-CCC* 1XXY-991214, CCC-06893898</p> <p>Het hierboven beschreven voorwerp is in overeenstemming met de desbetreffende harmonisatieverordening van de Unie.</p> <p>Toepasselijke richtlijnen: Harmonisatieverordeningen of andere technische specificaties</p>
<b>NL</b>	<p><b>Model / Type: ZK830</b></p> <p>Naam en adres van de fabrikant: Avery Weigh-Tronix® Foundry Lane Surrey Wick Woking, Surrey WIMBORNE B66 2LP ENGLAND</p> <p>Dit is een conformiteitsverklaring voor het verspreiden onder volgorde verantwoordelijkheid van de fabrikant.</p> <p>Objekt van de verklaring: ZK830 ZK830-PK0 ZK830 + ISO-XY-CCC* ZK830 + ZK830-PK0 + ISO-XY-CCC* 1XXY-991214, CCC-06893898</p> <p>Het hierboven beschreven voorwerp is in overeenstemming met de desbetreffende harmonisatieverordening van de Unie.</p> <p>Toepasselijke richtlijnen: Harmonisatieverordeningen of andere technische specificaties</p>

<b>IT</b> <b>Dichiarazione di Conformità UE</b>	<p><b>Modello / Tipo: ZK830</b></p> <p>Nome e indirizzo del fabbricante: Avery Weigh-Tronix® Foundry Lane Surrey Wick Woking, Surrey WIMBORNE B66 2LP INGHILTERRA</p> <p>L'oggetto della dichiarazione di conformità è rilasciato sotto la responsabilità esclusiva del fabbricante.</p> <p>Objet de la déclaration: ZK830 ZK830-PK0 ZK830 + ISO-XY-CCC* ZK830 + ZK830-PK0 + ISO-XY-CCC* 1XXY-991214, CCC-06893898</p> <p>L'oggetto della dichiarazione di cui sopra è conforme alla pertinente normativa di armonizzazione dell'Unione.</p> <p>Directive applicabili: Armonizzato norme o altre specificazioni tecniche</p>
<b>IT</b>	<p><b>Modello / Tipo: ZK830</b></p> <p>Nome e indirizzo del fabbricante: Avery Weigh-Tronix® Foundry Lane Surrey Wick Woking, Surrey WIMBORNE B66 2LP INGHILTERRA</p> <p>L'oggetto della dichiarazione di conformità è rilasciato sotto la responsabilità esclusiva del fabbricante.</p> <p>Objet de la déclaration: ZK830 ZK830-PK0 ZK830 + ISO-XY-CCC* ZK830 + ZK830-PK0 + ISO-XY-CCC* 1XXY-991214, CCC-06893898</p> <p>L'oggetto della dichiarazione di cui sopra è conforme alla pertinente normativa di armonizzazione dell'Unione.</p> <p>Directive applicabili: Armonizzato norme o altre specificazioni tecniche</p>

<b>ES</b> <b>Declaración UE de conformidad</b>	<p><b>Modelo / Tipo: ZK830</b></p> <p>Nombre y dirección del fabricante: Avery Weigh-Tronix® Foundry Lane Surrey Wick Woking, Surrey WIMBORNE B66 2LP INGLATERRA</p> <p>La presente declaración de conformidad se expone bajo la exclusiva responsabilidad del fabricante.</p> <p>Objeto de la declaración: ZK830 ZK830-PK0 ZK830 + ISO-XY-CCC* ZK830 + ZK830-PK0 + ISO-XY-CCC* 1XXY-991214, CCC-06893898</p> <p>El objeto de la declaración descrita anteriormente es conforme con legislación de armonización pertinente de la Unión.</p> <p>Directivas aplicables: Normas armonizadas u otras especificaciones técnicas</p>
<b>ES</b>	<p><b>Modelo / Tipo: ZK830</b></p> <p>Nombre y dirección del fabricante: Avery Weigh-Tronix® Foundry Lane Surrey Wick Woking, Surrey WIMBORNE B66 2LP INGLATERRA</p> <p>La presente declaración de conformidad se expone bajo la exclusiva responsabilidad del fabricante.</p> <p>Objeto de la declaración: ZK830 ZK830-PK0 ZK830 + ISO-XY-CCC* ZK830 + ZK830-PK0 + ISO-XY-CCC* 1XXY-991214, CCC-06893898</p> <p>El objeto de la declaración descrita anteriormente es conforme con legislación de armonización pertinente de la Unión.</p> <p>Directivas aplicables: Normas armonizadas u otras especificaciones técnicas</p>



76501-577 Issue 2

## 2 Introduction

The ZK830 is an indicator which, when attached to a BSQ digital scale base, creates a highly accurate counting, weighing and checkweighing system. The indicator, shown in [Figure 2.1](#) with the optional keypad, is easy to use. The indicator has two full duplex RS232 ports, one USB VCP (virtual comm port), Ethernet port, three logic level inputs with configurable functions, three setpoint outputs and an expansion card slot for 1 of 2 option cards:

- 802 Wireless card
- 5V Analog scale card

Other options available are a stack light kit for visual confirmation of outputs, two columns for mounting the indicator above the BSQ base, battery packs and scanners.

See the Specification literature for a full list of specifications.

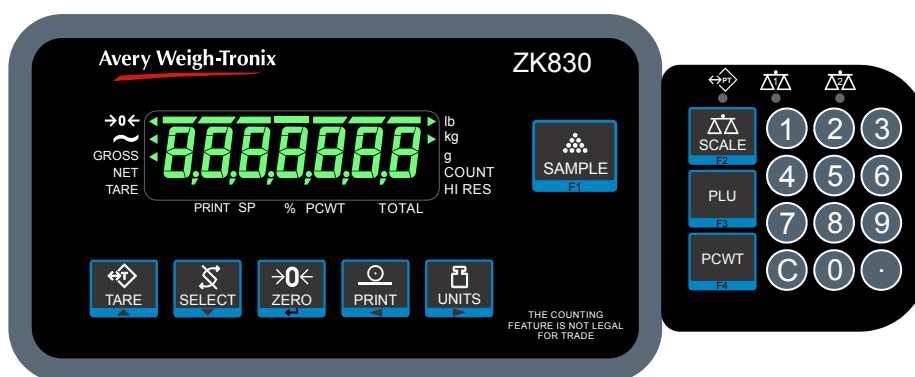

**Figure 2.1 ZK830 front panel with optional keypad**

The ZK830 can have a remote base attached which can be analog or digital.

For information on the BSQ bases please refer to the manuals for BSQ line.

### 2.1 Basic counting principles

There are several things which affect counting accuracy:

- environmental noise (vibration, wind, etc.)
- number of sample parts used
- the weight consistency of the sample parts
- the weight of one part
- accuracy requirement

Changes in each, or any one, of these variables can affect the accuracy for the better or for the worse. If there is wind or vibration accuracy will drop, especially if parts are small in weight. If parts are not a consistent weight, accuracy can be poorer but may be increased by using a large sample size.

Accuracy with this system can be extremely high, even with small parts, if the environment is controlled, parts have a consistent weight and a large enough sample size is used.











## 2.2 Front panel

The front panel, shown in [Figure 2.1](#), consists of the keys and display.



*Never press a key with anything but your finger. Damage to the overlay may result if sharp or rough objects are used.*

The normal function of the keys on the front panel are listed below. Some keys will have special functions in certain applications. Details are provided in the individual application sections.

	Press the <b>TARE</b> key to perform a tare function. With no weight on the scale, press the <b>TARE</b> key to clear a tare value. Acts as an up arrow key for menu navigation. Allows you to access minus and comma signs. Acts as an <b>ABORT</b> key during the sampling process.
	Press the <b>SELECT</b> key to toggle between the active display values. Press and hold to enter the setpoint editor in all applications. Acts as a down arrow key for menu navigation. Allows you to access minus and comma signs.
	Press the <b>ZERO</b> key to zero the display. Acts as an ENTER key to accept a displayed value or function.
	Press the <b>PRINT</b> to send information to a peripheral device through a configured communications port. Press and hold the <b>PRINT</b> key to print accumulated totals, if enabled. Acts as a left arrow key for menu navigation.
	Press the <b>UNITS</b> key to scroll through the available units of measure while in normal operating mode. Acts as a right arrow key for menu navigation. The <b>UNITS</b> key is disabled when displaying counts.
	Press the <b>SAMPLE</b> key to select application specific choices. Aborts a numeric entry and acts as an ESCAPE key in the menu navigation. Press and hold to view the password entry screen for menu access.
<b>Keys on the optional keypad shown below:</b>	
	Press the <b>SCALE</b> key to switch between two attached scales.
	Press the <b>PLU</b> key to access the PLU list. In the counting application this key can be used to update piece weight and or tare weight if enabled.
	Press the <b>PCWT</b> key to enter a known piece weight. If enabled, allows the user to see a high resolution weight value. In the count application allows you to enter or view piece weight values.
	Use the numeric keypad to enter values or clear a value from the display (C key).

## 2.2.1 Annunciators

The annunciators on the display are shown and labeled in [Figure 2.2](#).

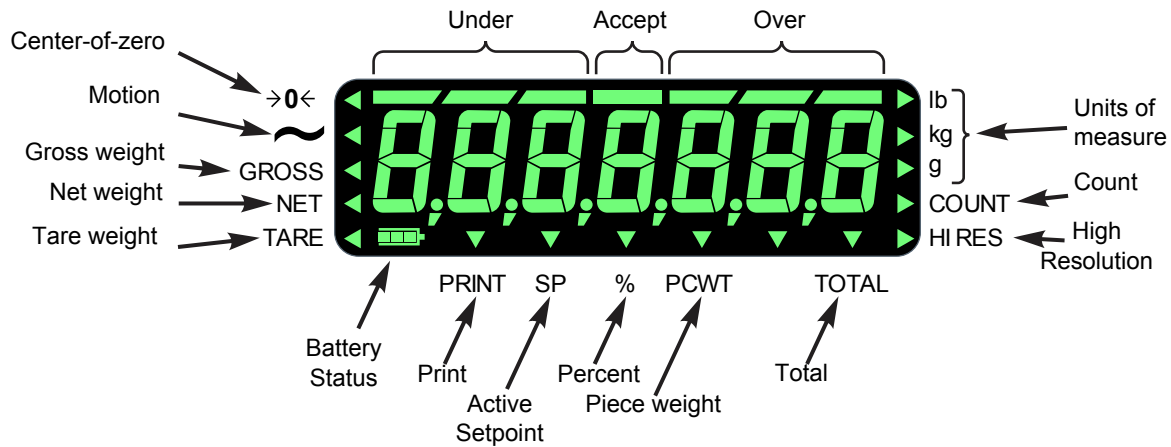

**Figure 2.2 Annunciators**

The triangular annunciators will light during operation to inform the user of the weighing mode, active unit of measure, etc.

## 2.3 Powering up the ZK830

The ZK830/BSQ comes with a base mounted AC power supply unit (PSU) connected to the back of the BSQ. This supplies the required input power of 12 to 36 VDC @ 200ma minimum and is connected to a properly grounded outlet (100 VAC - 240 VAC, 50 or 60 Hz). The indicator is always ON as long as power is received. See [Base mounted AC PSU on page 14](#).

If using the optional rechargeable battery pack mounted on the rear of the base you can expect approximately 16 hours of operation between charges. Recharge time is four hours using the in-line PSU. The battery pack requires 24 to 36V to charge. See [Battery power on page 15](#) for more information. The battery timer setting can be used to turn the indicator display OFF automatically.

You can also power the indicator with a 12 to 36 VDC power supply (150ma minimum at 24VDC) via a 2.1mm center positive barrel jack plugged into the receiver on the back of the indicator.

The first time you power up the ZK830 you need to pick which application you will be using. See [First time power up on page 17](#) for instructions on how to do this.

## 2.4 Connections on the BSQ

The BSQ comes with two different back panels, depending on the power option you choose. One is for AC power only and the other is for use with the optional battery pack or AC power. These two panels and their connections are shown in [Figure 2.3](#).

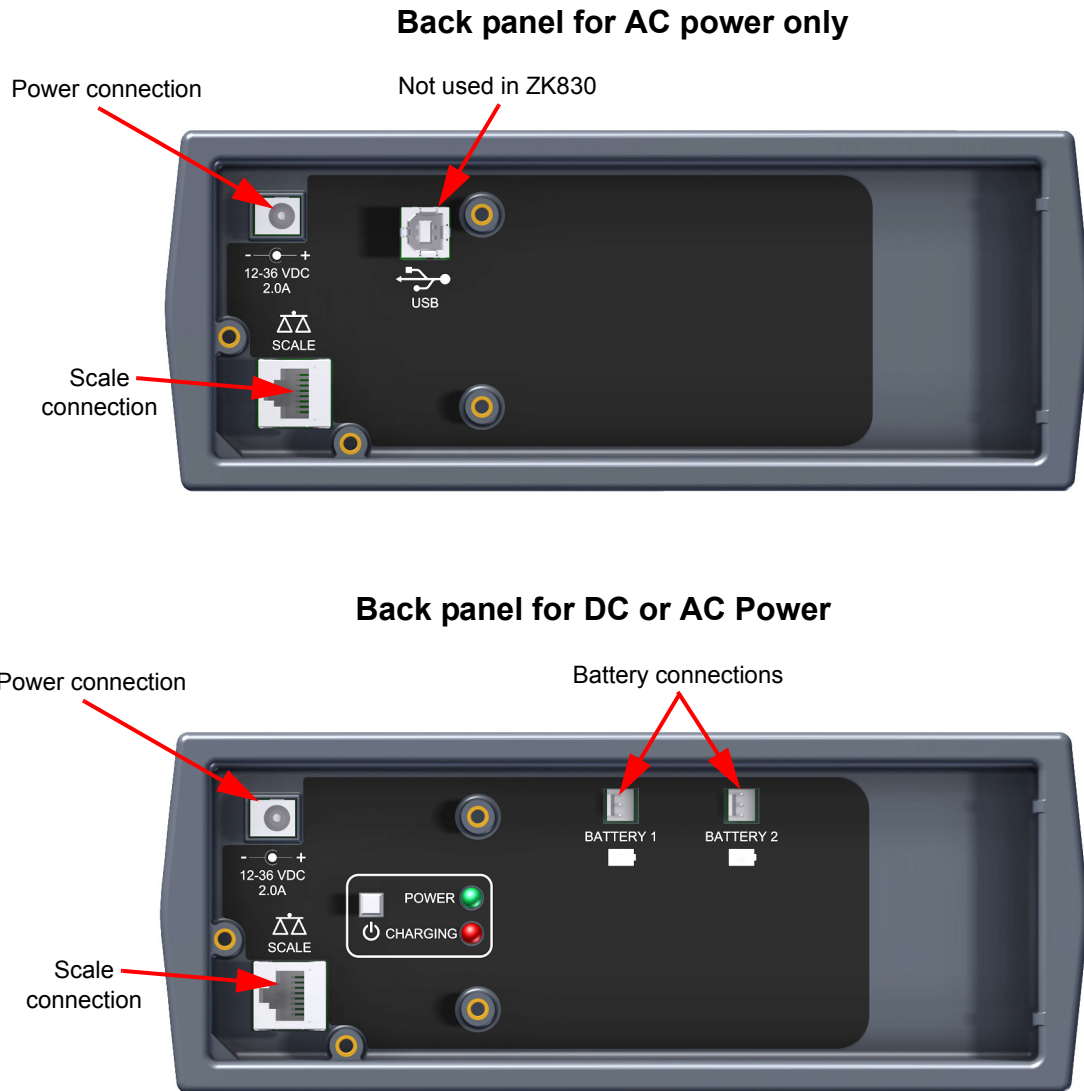

**Figure 2.3 BSQ connections**

## **Base mounted AC PSU**

On the Base mount model the AC power supply unit (PSU) is attached by a bracket to the back of the scale base. The DC output barrel jack plugs into the 12-36 VDC input as shown in [Figure 2.4](#).



**Figure 2.4 AC power block**

Plug the power cord into a properly grounded outlet, then into the receptacle in the PSU. See [Figure 2.5](#).



**Figure 2.5 AC power connections**

## Battery power

The optional battery pack connects to the two battery connections as shown in [Figure 2.6](#). The battery provides approximately 16 hours of operation before charging is necessary.

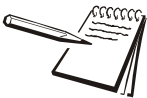

**Figure 2.6** Battery pack connections

When a 24-36 VDC power supply is plugged into the power connection on the back panel of the ZK830, the green POWER light will turn on indicating power has been applied to the BSQ base. The red CHARGING light will blink to indicate the battery is charging. When the battery is fully charged the red CHARGING light will go out and the power supply can be unplugged to work on battery power only.

The standby power button, pointed out in [Figure 2.6](#), can be used to turn the ZK830 indicator on or off.

## 2.5 Leveling the scale



*For best accuracy we recommend you check that the scale is level prior to every use.*

Place the scale on a level, stable surface free from vibrations or strong air currents. Level the scale using adjustable feet and the bubble level located on the side of the base. Turn the appropriate foot or feet until the bubble is centered and then lock the feet in place by turning the locking collar snugly up against the scale body. See [Figure 2.7](#).

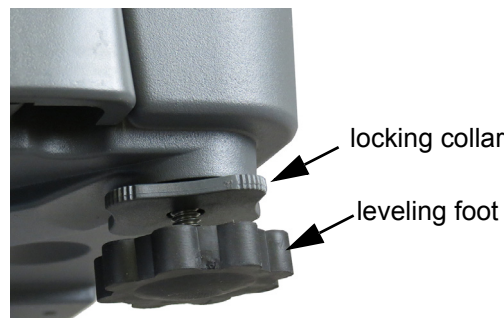

**Figure 2.7** Foot and locking collar

## 2.6 Numeric entry procedure (without optional keypad)

---

The keys in [Figure 2.8](#) have alternate functions in numeric entry screens.

	These segments flash in numeric entry mode
<b>TARE / ▲</b>	– Press to increment the flashing number
<b>SELECT / ▼</b>	– Press to decrement the flashing number
<b>PRINT / ◀</b>	– Press to backspace cursor in a number
<b>UNITS / ▶</b>	– Press to advance cursor in a number
<b>ZERO / ↵</b>	– Press to accept a value
<b>F1 / ESC</b>	– Press to escape an entry screen

**Figure 2.8 Key function during numeric entry**

In numeric entry screens, the center segments shown in [Figure 2.8](#) flash. Use the keys, as described in [Figure 2.8](#), to enter a value on the display. Following is an example:

### **Example: To key in the number 507:**

Repeatedly press the **TARE(▲)** or **SELECT(▼)** key until **5** appears on the display.

Press the **UNITS(→)** key once to move cursor one space to the right.

Repeatedly press the **TARE(▲)** or **SELECT(▼)** key until **0** appears on the display.

Press the **UNITS(→)** key once to move cursor one space to the right.

Repeatedly press the **TARE(▲)** or **SELECT(▼)** key until **7** appears on the display.

Press the **ZERO** key to enter or accept the value.

Press the **PRINT(◀)** key to move the entry function one digit to the left. This effectively deletes the current value in that position and allows you to enter a new value in that position.

## 2.7 Numeric entry procedure (with optional keypad)

---

Use the optional numeric keypad to enter all numbers. Press the **ZERO** key to enter or accept the value.

## 2.8 Printing

---

There are several default print formats that can be used but these are configured or customized as part of the setup by a programmer or qualified service technician.



## 3 Indicator applications

This indicator has three weighing applications that can be enabled through a password protected menu. Only one application can be enabled at a time. The applications available are:

- **Parts Counting** (explained on page 17)
- **General Weighing** (explained on page 23)
- **Checkweighing** (explained on page 27)



---

*Key functions in different applications may vary. These will be noted under each application.*

---

### 3.1 First time power up

---

Upon first time power up you are given the choice of which application you want to use. **APP** appears on the screen. Press **SELECT** and use the **UNITS** or **PRINT** key to scroll through the choices. When the application you want to use is displayed, press **ZERO**. That application will become active. Press the **TARE** key to start the normal mode for the chosen application.

A password protected menu is used to change the active application.

#### To display active application name

You can display the active application name by doing one of the following:

- Press and hold **SAMPLE/F1** until the numeric entry screen appears. Press **SAMPLE/F1** again to display the current application name.
- Or
- Cycle power and the current application name is displayed briefly on power up.

### 3.2 Counting application

---

This section applies if the Count application is active.

#### 3.2.1 Sampling methods

Dribble sampling is the default sampling method. Bulk sampling is also available. This is set in a password protected Supervisor menu. Each type is defined below.

##### ***Dribble sampling definition:***

When sample parts are being added to the scale they can be counted out slowly or, in other words, dribbled onto the scale. A key press (**SAMPLE** key) is needed to finish the sampling process. The piece weight is calculated and the count is displayed.

### **Bulk sampling definition:**

When sample parts are being added to the scale they must all be placed on the scale at once, in other words, in bulk. If the sample is large enough to meet the minimum weight requirements the piece weight is calculated and the count is displayed with no extra button presses.



---

*At any time during the sampling process you can abort by pressing the **TARE/up arrow** key.*

---

## **3.2.2 Remote base switching (optional keypad required)**

If you have an extra base installed with the BSQ (it can be analog or digital), you can switch between the two by pressing the **SCALE** key. Either scale can be used to take samples. If enabled you can sample on one base and the display automatically switches to the other scale for counting. Either base can be selected as the sampling base.

## **3.2.3 Entering known tare weights and piece weights (optional keypad required)**

If you know a tare or piece weight you can quickly enter those values using these steps:

### **Entering a known tare weight (only if optional keypad attached)**

In gross weight mode (*GROSS* annunciator lit), key in a tare weight and press the **TARE** key. The tare weight is active and the *NET* annunciator lights.



---

*To clear a tare weight, remove all weight from the scale and press the **TARE** key or press and hold the **TARE** key for three seconds.*

---

### **Entering a known piece weight**

Key in a known piece weight and press the **PCWT** key. The piece weight becomes active.

To view the current piece weight, press the **PCWT** key and the piece weight will be shown for five seconds.

## **3.2.4 SELECT key default function**

In the Count application you can view the gross, net, count and count total values by repeatedly pressing **SELECT**.

### 3.2.5 Special key functions

The following keys have an extra function in this application:

**SAMPLE** Press **SAMPLE** to perform the sample operation as described below in the Sampling section.

**PRINT** Press the **PRINT** key to perform the print function and to add the count to the accumulator, if enabled.

Press and hold the **PRINT** key to print the total print format chosen in the password protected Supervisor menu.

### 3.2.6 Sample size

By default the sample size choices are 1, 2, 5, 10, 25, 50 or 100. When asked to add samples, one of these will be the requested count. The default sample size is defined in the password protected Supervisor menu.

#### Alternate sample sizes (only with optional keypad)

If you want to use a different sample size than the default ones, key in the quantity you want to use (it must be larger than the default size) and press the **SAMPLE** key. The display will show **SAMPLinG** briefly and then **Add XX**, where **XX** is the size you keyed in.

### 3.2.7 Counting in dribble mode

With the count application in dribble mode active, follow these steps to count:

1. Press **ZERO** to zero the scale, if necessary.
2. Use a tare method to tare a container, if necessary. See [Net weighing on page 23](#).
3. Press the **SAMPLE** key...

**SAMPLinG** is briefly displayed. This means the indicator is zeroing itself. A message, **Add XX**, is then displayed. **XX** is the current sample size.

- 4a. Place **XX** number of items on the scale.

**OR**

- 4b. Press the **SELECT** key repeatedly to scroll through other sample size choices (1, 2, 5, 10, 25, 50 or 100). When your choice is displayed, place that number of items on the scale and press **SAMPLE** ...

**buSY** is briefly displayed, followed by one of three possible outcomes:

- a. If the sample met the minimum sample requirements and the weight is stable, the display will show the correct number of parts on the scale and the **COUNT** annunciator is lit.
- b. If the sample weight was not enough, **Add XXX** will be displayed. Add **XXX** parts and press the **SAMPLE** key.

- c If the sample weight was not enough or if the weight was unstable, **tMout** is briefly displayed and the display returns to gross weighing mode. Repeat steps 3 through 5 using a larger sample size. The **TARE** key can be used to abort the sampling process, if necessary.



---

*If you do not place a sample on the scale within five minutes of selecting the sample size, the display will show **tmout** (timeout) and return to the gross weight screen.*

---



---

*Minimum sample weight is defined as 0.01% of capacity in dribble mode or 0.02% of capacity for bulk mode.*

---

5. Place the parts on the scale to be counted. If enabled you can accumulate the count and number of transactions by pressing **PRINT** while in count mode.
6. If enabled, press and hold **PRINT** for three seconds to print and/or clear the active count total. These functions are enabled or disabled in a password protected menu.



---

*Press **SELECT** to see the accumulated count total. The total is erased when a new piece weight is established, a new PLU is selected or the if the ZK830 is powered off.*

---

### **3.2.8 Counting in bulk mode**

With the count application in bulk mode active, follow these steps to count:

1. Press **ZERO** to zero the scale, if necessary.
2. Use a tare method to tare a container, if necessary. See [Net weighing on page 23](#).
3. Press the **SAMPLE** key...

**SAMPLInG** is briefly displayed. This means the indicator is zeroing itself. A message, **Add XX**, is then displayed. **XX** is the current sample size.

- 4a. Place **XX** number of items on the scale.

**OR**

- 4b. Press the **SELECT** key repeatedly to scroll through other sample size choices (1, 2, 5, 10, 25, 50 or 100). When your choice is displayed, place all the sample on the scale at one time ...

**buSY** is briefly displayed, followed by one of two possible outcomes:

- a. If the sample met the minimum sample requirements and the weight is stable, the display will show the correct number of parts on the scale and the **COUNT** annunciator is lit.

**OR**

- b If the sample size was not large enough or if the weight was unstable, **tMout** is briefly displayed and the display returns to gross weighing mode. Repeat steps 3 through 5 using a larger sample size. The **TARE** key can be used to abort the sampling process, if necessary.



---

If you do not place a sample on the scale within five minutes of selecting the sample size, the display will show **tmout** (timeout) and return to the gross weight screen.

---

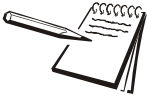



---

Minimum sample weight is defined as 0.01% of capacity in dribble mode or 0.02% of capacity for bulk mode.

---

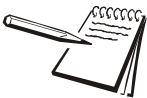
5. Place the parts on the scale to be counted. If enabled you can accumulate the count and number of transactions by pressing **PRINT** while in count mode.
6. If enabled, press and hold **PRINT** for three seconds to print and/or clear the active count total. These functions are enabled or disabled in a password protected menu.



---

Press **SELECT** to see the accumulated count total. The total is erased when a new piece weight is established, a new PLU is selected or the if the ZK830 is powered off.

---

### 3.2.9 Using PLUs (optional keypad only)



---

**CAUTION:** Using a PLU assumes the individual piece weights are identical between batches. If humidity or manufacturing tolerances can affect your parts and you are unsure if piece weights are the same, you may get more accurate counting if you do a new sample to get the latest piece weight.

---

PLUs (Part Look Up) are use to quickly recall up to 40 items' tare and piece weights using a number (1-40) and the PLU key. You can also enter the part number associated with the PLU number. It must be a 3-7 digit part number. PLUs are entered into the ZK830 through the password protected Supervisor menu.

To recall a PLU, key in the PLU number or the 3-7 digit part number and press **PLU**. The stored piece weight, tare weight and units are now active.

Repeat this process for other PLUs.

#### Updating PLU stored tare and piece weights

If enabled in the password protected Supervisor menu, you can update the stored tare weight for a PLU or a piece weight. With an active PLU, to update a either weight press the **PLU** key and the current PLU number is displayed, press the **PLU** key twice and **uPdAting** is briefly displayed. The new tare and/or piece weight is now stored.

### **Deactivating a PLU (optional keypad only)**

To stop using a PLU's values, press 0 and then **PLU**. The display will show **PLU Off**. This will clear all the values being used for that PLU and will return the scale to gross weight mode.

### **3.2.10 Check counting**

You can fill boxes within a specific upper and lower count limit. The bar graph will show when you are under/over or at the accept number. Or if you have the optional light stack, the lights can alert you to the count status.

Upper and lower limits can be stored in each of the (1-40) PLUs or a supervisor can set fixed upper and lower limits that are always active until a PLU is recalled. If the PLU is canceled the fixed limits become active again. See the illustration below.

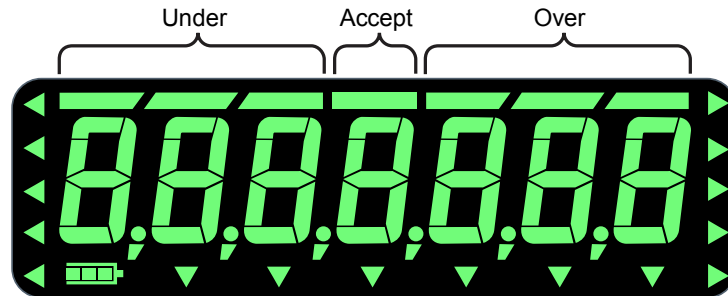

## 3.3 General weighing application

---

This section applies if the General Weighing application is active. Features described here also apply to the other applications except where noted in those application instructions.

In General weighing you can do the following:

- Gross, tare, net weighing
- Switch between the local BSQ base and a remote BSQ or analog scale, if installed
- High resolution weighing, if enabled
- Percentage weighing, if enabled
- Weight accumulation, if enabled
- Use 40 preset tares, if enabled

### 3.3.1 SELECT key default function

---

In the General Weighing application you can view the gross, net, tare, net total, gross total, percent display and high resolution values by repeatedly pressing **SELECT**.

### 3.3.2 Gross weighing

---



---

To change unit of measure, press **UNITS**.

---

To perform gross weighing, power up the unit and follow these steps:

1. Empty the scale and press **ZERO** to zero the display ...  
     **0** is displayed and the *center-of-zero* annunciator (→**0**←) lights.
2. Place item to be weighed on the scale ...  
     Weight is displayed.
3. Repeat steps 1 and 2.

### 3.3.3 Net weighing

---

Net weighing is available via three types of tare entry if the optional keypad is attached:

- Pushbutton tare** When enabled press **TARE** to tare the weight on the scale.
- Entered tare** When enabled you can enter a tare value using the optional keypad. This type of tare is not available if the keypad is absent.
- PLU tare** If you have PLUs in memory, the PLU can be recalled and this activates the associated tare value. If two scales are active, the PLU can store a tare for each scale separately.

There is an auto tare clear feature. If this is enabled, after a weighment, when the weight falls into the gross zero band, tare is cleared.



---

*Definition: Gross zero band - this is a configured value that defines a window around gross zero. This is used in several ways in different applications.*

---

### **Using Pushbutton Tare**

---

To perform a net weighment using pushbutton tare, power up the unit and follow these steps:

1. With no weight on the scale, if the display does not read **0** press **ZERO** ...  
**0** is displayed and the *center-of-zero* annunciator lights.
2. Place item to be tared on the scale ...  
Weight is displayed.
3. Press **TARE** ...  
**0** is displayed and the *NET* annunciator lights.
4. Place material to be weighed onto the scale ...  
Net weight of material is displayed.
5. Repeatedly press **SELECT** to view the configured display values.
6. If repeated weighments use the same tared item, you do not need to establish a new tare value as described in step 2 and 3.

### **Using Entered Tare (with optional keypad only)**

---

If enabled you can enter in a tare value using the optional keypad and this procedure.

1. Key in a tare weight using the keypad and press the **TARE** key to accept the value ...  
The new tare value is now active. The displayed gross weight will now be the negative of the tare value.
2. Place the container and the material to be weighed on the scale ...  
Net weight of material is displayed.

### **Using PLU tares (with optional keypad only)**

---

PLU tares that are created and edited via the password protected Supervisor menu, can be recalled using the following steps.

1. Press **ZERO** to zero the scale, if necessary.
2. Key in the PLU number (1-40) or the 3-7 digit part number and press **PLU** ...  
The tare value associated with that PLU is recalled and is now active. The display will show a negative value (equal to the tare value).



3. Place the container on the scale ...  
The scale should read 0.
4. Place the items to be weighed on the scale.

### To Clear a Tare

Remove all weight from the scale and press the **TARE** key. The display shows **tArEcLr** briefly, the tare is cleared and the display will change to gross mode.

### 3.3.4 High resolution weighing (if enabled)

To momentarily view a higher resolution weight value, press the **PCWT/F4** key. The weight will be displayed with an extra digit of resolution for five seconds. This is only available in the general weighing application.

### 3.3.5 Percentage weighing

If enabled you can use the scale to measure a percent weight gain or loss from a target weight.

Clear the scale and be sure there is no active tare and press **ZERO** to zero the scale if necessary.

Press the **SELECT** key repeatedly until the % annunciator is lit.

Place the target weight on the scale and press **SAMPLE/F1**. The display shows **0.0**.

Add or remove weight until the display shows the desired percentage gain or loss.

When finished, you can return to gross weighing by pressing the **SELECT** key until the **GROSS** annunciator is lit.

### 3.3.6 Using setpoints

Setpoints are values (weight) at which outputs are triggered automatically. Outputs can control relays connected to valves, lights, other machinery, etc. See the [Supervisor menu on page 45](#) for information on how to edit or enter setpoint values.

See the note below for an overview of how setpoints function.



*If activated, setpoints behave differently in the different applications. See the table below:*

	<b>Below Value</b>	<b>Above Value</b>
<b>General App.</b>	<b>OFF</b>	<b>ON</b>
<b>Count App.</b>	<b>UNDER ACCEPT OVER</b>	
<b>Checkweigher App.</b>	<b>UNDER ACCEPT OVER</b>	

### **3.3.7 Printing**

To print the current weight information, press **PRINT**. The configured print format will be output through the configured port to the connected peripheral device.

## 3.4 Checkweighing application

---

This section applies if your indicator has the Checkweighing application enabled.

### 3.4.1 **SELECT** key default function

In the Checkweighing application you can view the gross, net and tare display values by repeatedly pressing **SELECT**.

### 3.4.2 **Special key functions**

The following keys have an extra function in this application:

**SAMPLE/F1** Press **SAMPLE/F1** to set the target weight or upper and lower limits, as described below.

### 3.4.3 **Checkweighing operation**

Checkweighing allows a quick, visual check of the acceptability or unacceptability of an item's weight. [Figure 3.1](#) shows the checkweighing bargraph at the top of the display.

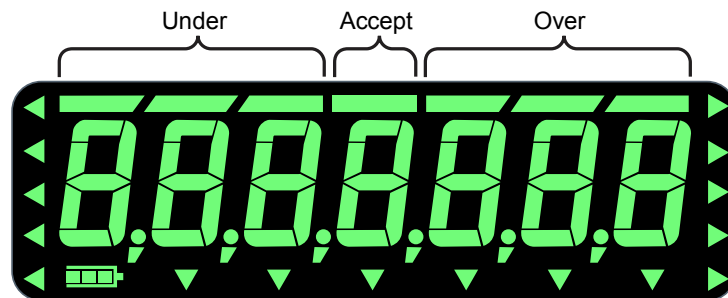

Figure 3.1 Checkweighing bargraph

Checkweighing can be done by two methods

#### ***Sampling a target weight with the SAMPLE key***

Use this method to set the target weight. Place the object on the scale and press the **SAMPLE** key. This becomes the target weight and any weight within  $\pm$  a predefined range (default is  $\pm 1$  division) will be acceptable. To change this range you must use the password protected Supervisor menu.

#### ***Setting upper and lower weight limits***

The ZK830 can have up to 40 preset upper and lower limits via the PLU database. These are created and edited using the password protected Supervisor menu.

Each of these is explained below.



---

*The checkweighing annunciators are based off of net weight so if a tare is active only the net weight is considered for checkweighing. If there is no tare, gross weight is used as the basis for the annunciators.*

---

### **3.4.4 Weighing a target object**

With the indicator in checkweighing mode, follow these steps to set a target by weighing an object.

1. Press **ZERO** to zero the scale, if necessary.
2. Enter a tare if necessary. Refer to [Net weighing on page 23](#) for instructions.
3. Place an object of the desired weight on the scale and press **SAMPLE/F1** ...

The weight is displayed and the middle bargraph segment lights as well as the *SP* annunciator.



---

*The acceptable target window is a range from **Target Object weight ± a predefined range** entered in a password protected menu.*

*The farther the weight is from the target weight, more over or under bargraph segments will light. The **UNDER** and **OVER** bargraph segments are equal to a number of divisions set in a password protected menu.*

---

4. Remove the object and replace with the next object to be checked.

The bargraph will show if the weight is under, over or within the target weight range. If the weight is under, *the SP* annunciator and the *UNDER* bar segments will light. If the weight is over, the *SP* annunciator and the *OVER* bar segments will light.

5. Repeat step 4 until you are finished weighing items.

The current target weight will be active until you repeat steps 1 through 3 with a new item of a different weight.

### **3.4.5 Checkweighing using PLUs (with optional keypad only)**

The PLU database contains tare values and upper and lower weight limits for up to 40 items.

To recall a PLU, key in the PLU number (1-40) or the 3-7 digit part number and press the **PLU** key.

The tare and weight limits become active and you can begin to weigh your items.

To clear a PLU press **0** and then the **PLU** key. This will clear the current values for tare and weight limits.

### **3.4.6 Accumulating gross and net weights**

If enabled you can press the **PRINT** key to accumulate gross and net weights. You can then press the **SELECT** key to scroll through the gross, net and transaction totals.

## 4 Menus

Password protected menus are available to configure the indicator and/or view information.

### 4.1 Accessing the menus

---

Follow these steps to access the menus in the ZK830.

1. With the indicator powered up and in normal operating mode, press and hold **SAMPLE/F1** ...

**Pass** is displayed, prompting you to enter the password.

2. Key in the password for the menu you want and press the **ZERO** key ...

The first item in the top level of the menu you accessed is displayed.

3. Use the navigation keys, shown below, to navigate through the menu structure. The symbols in the chart appear on the bottom of the keys.

Press **SELECT/ ▼** to move down in a menu  
 Press **TARE/ ▲** to move up in a menu, except at the bottom item in a menu, then use **ZERO/ ←** or **SAMPLE/F1**  
 Press **PRINT/ ◀** to move left in a menu  
 Press **UNITS/ ▶** to move right in a menu  
 Press **ZERO/ ↵** to accept a value or choice and move up in the menu.  
 Press **SAMPLE/F1** to escape and move up in the menu

### 4.2 Menu annunciators

---

The menu structure is made up of menu items, parameters, value entry screens and lists from which you choose one item. To help you know where you are in the menu, the bargraph at the top of the display is on while the indicator is in the menus and will change appearance according to the following rules:

<b>All segments flashing</b>	This means you are in the menu structure but not in any of the following screens.
<b>Center flashing / others solid</b>	This means you are in a parameter prompt screen.
<b>Center flashing / others off</b>	This means you are in a numeric entry screen. Enter a number and press <b>ZERO</b> to accept.
<b>Right flashing / others off</b>	This means you are in a list. Scroll through the choices with the <b>PRINT</b> and <b>UNITS</b> keys and press <b>ZERO</b> to accept.

## 4.3 Exiting the menus

---

1. If you are at the bottom item in a menu use **ZERO** to accept a choice or value and move up a level, or use **SAMPLE/F1** to escape and move up one level without accepting the choice or value. From that point, press **TARE** repeatedly until ...

**SAVE no** is displayed. This means “Do not save changes.”

2. Press **UNITS** to scroll through the choices: **SAVE no**, **SAVEYES** and **CAnCEL**. Press **ZERO** to accept the displayed choice.

If you choose **SAVE no** or **SAVEYES** the indicator exits the menu and returns to normal weighing mode.

**OR**

If you choose **CAnCEL**, the indicator remains in the menu.

## 4.4 USER level menus

---

The USER level menus are available to the user. The other menu levels are for supervisors and technicians only.

The USER level (password 111) contains the User, About, and Audit menus arranged as shown in [Figure 4.1](#).

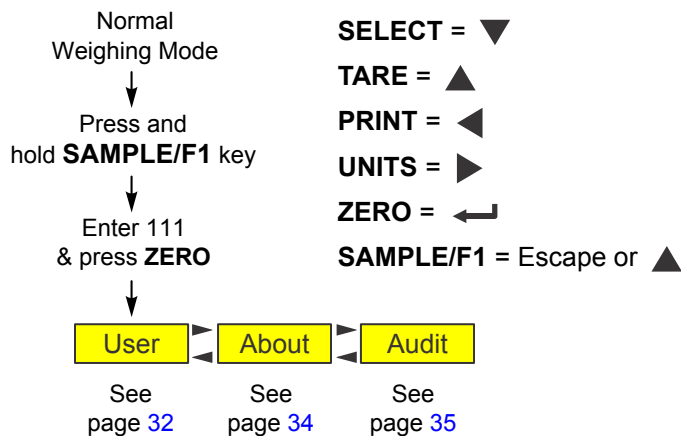

**Figure 4.1 USER level (password 111) menus**

## 4.5 User menu

The User menu is shown in Figure 4.2.

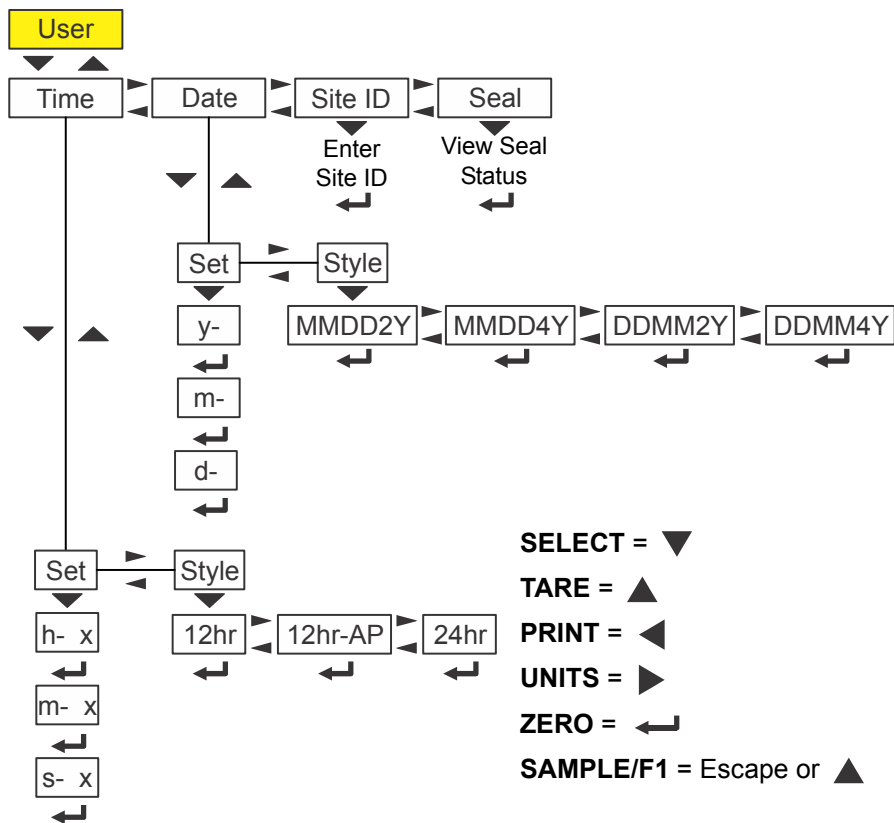

Figure 4.2 User menu

Use the [Numeric entry procedure \(without optional keypad\)](#) on page 16 when you need to enter values.

### 4.5.1 Time

Access the User menu (see [Accessing the menus on page 30](#)). Use the navigation keys to move to the item you wish to configure. Each item is explained below.

**tiME** Use this to set the time and clock style. Two items appear below **tiME**:

**Set** Use this to set the hour, minute and second.

**h- x** This is the entry screen for the hour.

**m- x** This is the entry screen for the minute.

**s x** This is the entry screen for the second.

**StYLE** Use this to set the style of clock for printouts. Choices are **12hr**, **12hr-AP** (AM/PM) and **24hr** (military time).



**dAtE** Use this to set the date and style of its appearance. Two items appear below **dAtE**:

**Set** Use this to set the hour, minute and second.

**y-** This is the entry screen for the year.

**m-** This is the entry screen for the month.

**d-** This is the entry screen for the day.

**StYLE** Use this to set the style of clock for printouts. Choices are **MMDD2Y**, **MMDD4Y**, **DDMM2Y** and **DDMM4Y**.

**SitE id** Use this to key in a site ID number.



---

*The Site ID can be used in transmitted or printing information. ASCII characters 32-126 can be used.*

---

**SEAL** Use this to view the Seal status. This is the status of the physical seal inside the indicator. If the unit is sealed, no changes can be made to the configuration of the indicator. **unSEAL** or **SEALed** is displayed.

To exit the menu, see [Exiting the menus on page 31](#).

## 4.6 About menu

The About menu is shown in [Figure 4.3](#).

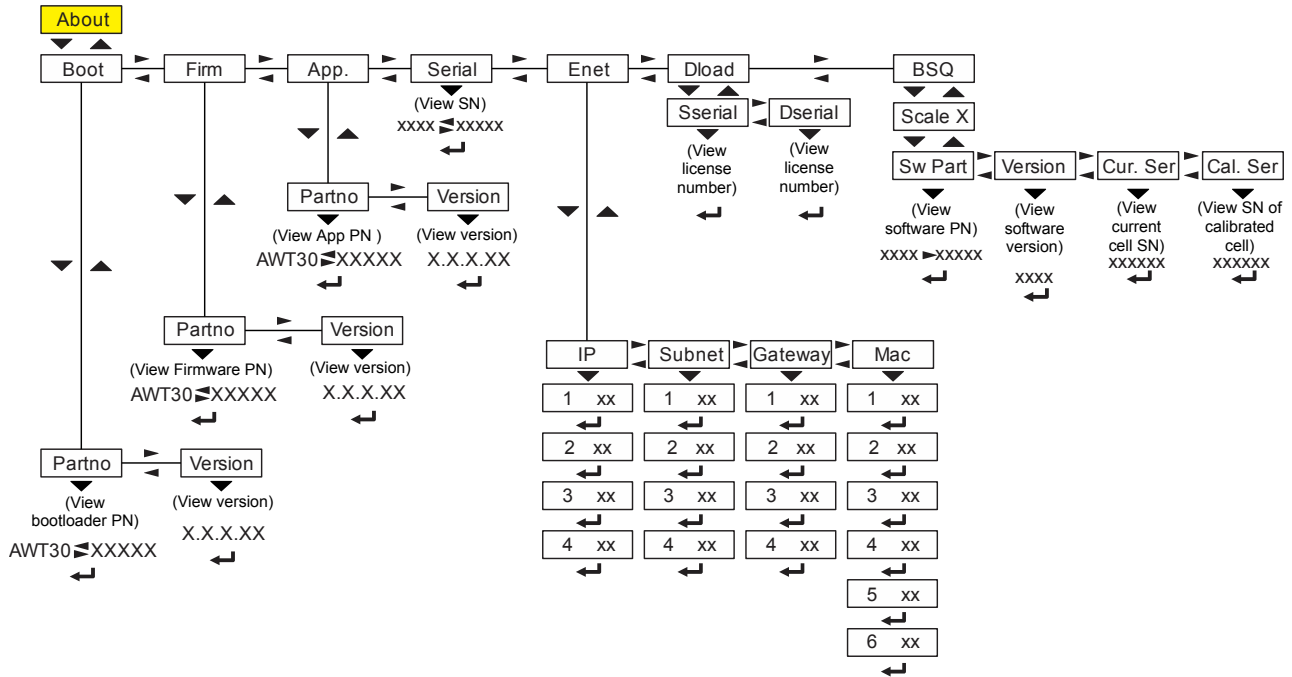

**Figure 4.3 About menu**

Use this menu to display information about the various items shown in [Figure 4.3](#). Each is explained below.

**boot** Use this to view the bootloader part number (PN) and version number.

When you view the bootloader PN only the 1st half is shown until you press **UNITS** to view the 2nd half.

**FirM** Use this to view the firmware part number and version. You need to press **UNITS** to view the 2nd half of the part number.

**APP** Use this to view the application part number and version. You need to press **UNITS** to view the 2nd half of the part number.

**Serial** Use this to view the serial number of the indicator. The first four digits are displayed. Press **UNITS** to view the last five digits.

**EnEt** Use this item to view the values for the IP, Subnet, Gateway and MAC addresses. Press the **ENTER** key successively to see all parts of the addresses.



*If the indicator is connected to an ethernet network, the values displayed will be the current assigned addresses.*

- dLoAd** This stands for download. Under **SSErIAL** you can view the serial number of the software application that created the configuration file. Under **dSSErIAL** you can view the serial number of the software application that downloaded the configuration file. This is used for security and licensing purposes.
- bSq** Use this to view the software part number, software version, serial number of the currently connected load cell and the serial number of the load cell the indicator was calibrated to. These last two items must match or you will see a BSQ error displayed.

This completes the About menu. To exit the menu, see [Exiting the menus on page 31](#).

## 4.7 Audit menu

The Audit menu is shown in [Figure 4.4](#).

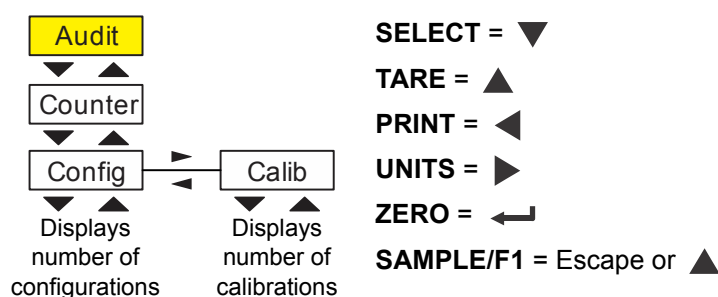

**Figure 4.4** Audit menu











Use this menu to display audit counters for configuration and calibration. Each is explained below. Use the [Numeric entry procedure \(without optional keypad\) on page 16](#) when you need to enter values.

- countEr** Use the Audit menu to view the two counters that tell you how many times the indicator has been configured and calibrated.

This completes the Audit menu. To exit the menu, see [Exiting the menus on page 31](#).

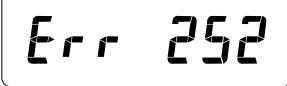
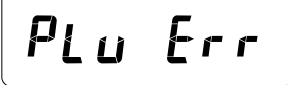
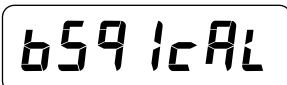
## 5 Error messages

The following error messages may be displayed during use of the indicator:

Message / Fix	Display
Overload / Remove weight causing the error	
Underload / Check for obstruction under the load platter	
Can't / Request failed due to motion or other invalid condition	
Bounds / Entry not in valid range	
Invalid / Password entry failed	
Z-error / Power up zero error	
Error 252/ Scale not communicating - check interface cable from scale to indicator, contact scale service provider if error continues	
Recalled PLU has a pieceweight of 0.	
BSQ Cal Error / ZK830 and BSQ have not been calibrated together. If the remote scale is a BSQ the 1 shown in the illustration will be a 2.	
Z-Lock / Indicator did not reach a stable zero weight within time window set for automated weighing process.	  

## 6 String index/character data entry

In the User menu there is an entry, Site ID, that requires you to enter text in a seven digit string. Below are guidelines to create or edit text in this string. This is a sample of a string entry display.

When these segments are flashing, you are in the string index select mode. In this mode you select the index character you want to edit or add/delete a character.



String Index  
number

Character  
(ASCII characters  
are entered as  
decimal values)

Left-flashing bar graph segments indicate you are in the String Index select mode. Use the Table 1 key legend to:

- move to the index number you want to edit
- add a new index number
- delete an existing index number.

Table 1: Key Action When In The String Index Select Mode						
Action	TARE	SELECT	ZERO	PRINT	UNITS	F1
<b>Momentary Key Press</b>	Does nothing	Selects the index character for editing using the key actions in Table 2	EXIT	Moves left one position in the index	Moves right one position in the index	ESC/Abort
<b>Long Key Press</b>	Deletes current character	Append new character after this point Default character added is 32 (space)	Does nothing	Page Up (Decrements index by 10)	Page Down (Increments index by 10)	Does nothing

After you select the index number, use the Table 2 key actions to edit the character for that index number.

Table 2: Key Action When In The Character Edit Mode						
Action	TARE	SELECT	ZERO	PRINT	UNITS	F1
<b>Single Key Press</b>	Increments the flashing digit by 1	Decrements the flashing digit by 1	Enter	Delete flashing digit	Add Digit	ESC/Abort
<b>Long Key Press</b>	Move flashing digit left	Move flashing digit right	Does nothing	Delete the entire entry	Does nothing	Does nothing

## 7 Options

The ZK830 has several options which are available to increase its usefulness in certain situations.

### 7.1 Remote keypad

---

The remote keypad provides easy number entry, access to the function of a second scale, a PLU database and easy piece weight entry.



### 7.2 Light stack

---

The light stack provides quick, visual feedback on the status of checkweighing and check counting functions. Over, under and accept lights as well as an alarm can be triggered by the ZK830 to alert users. The light stack can be mounted in multiple positions on the scale base or optional column.



## 7.3 Debris shield

---

The debris shield fills the gap between the BSQ base and the ZK830 to prevent debris from falling behind the indicator.



## 7.4 Desk/wall mount

---

The desk/wall mount bracket attaches easily to the indicator and allows for easy use on a wall or desktop.



## 7.5 Columns

---

The ZK830 indicator can be mounted one of two columns available as options: one is 15" (38cm) and the other is 23" (58.5cm) tall.



## 7.6 Draft shield

---

The draft shield offers protection from drafts which can adversely affect the function of the scale when weighing small parts. All four sides open for easy access.





## 7.7 Underhook

---

An underhook kit allows weights to be suspended beneath the BSQ base.

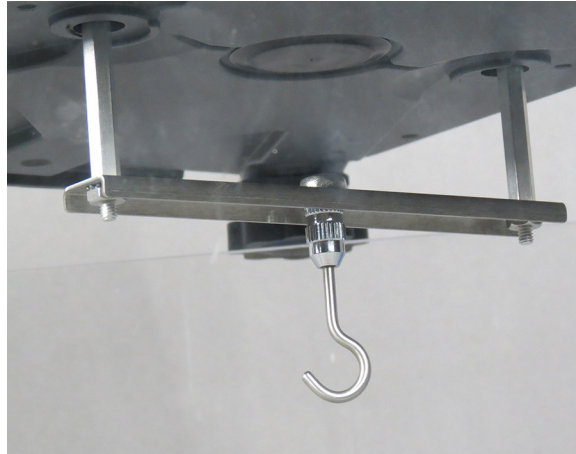

## 7.8 Ball top

---

The ball top allows easy movement of heavier objects especially in assembly line situations. Only available on the 12" x 14" (30.5cm x 35cm) base.



## 7.9 Batteries

---

There are two rechargeable battery options to choose from: a battery pack on the back of the BSQ base (see page 15) and the ZQ BAT which can be used in combination with the column option. The first can give approximately 16 hours of operation and the second can give 25 hours of continuous use or 1-2 weeks of occasional operation.



ZQ BAT  
attached to  
back of the  
column

## 7.10 Clamp down plate

---

The clamp down plate holds down the BSQ base and makes the ZK830 secure for transporting on carts and trolleys.

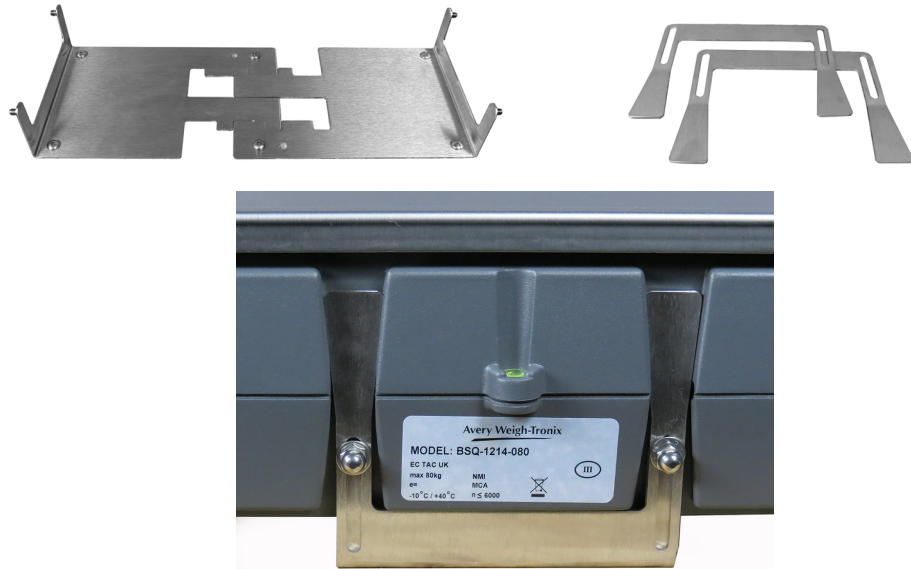

## 7.11 802 wireless option card

---

The 802 wireless option card allows the ZK830 to communicate wirelessly to many peripheral devices. This must be installed by a qualified technician.

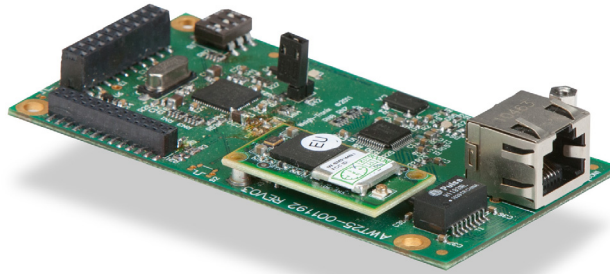

## 7.12 Remote base analog card

---

The 5V remote base analog card allows the connection of second analog scale to the ZK830 for remote weighing. This must be installed by a qualified technician.

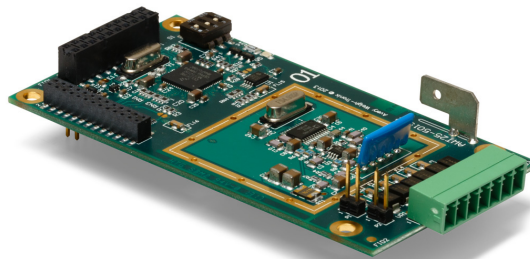

## 7.13 Printer

---

Printers of several styles are available for use with the ZK830. A range of compatible printers can be used with the ZK830. One style, available through Avery Weigh-Tronix, is shown below.



## 7.14 Scanner

---

A barcode scanner can help speed up inventory processes. A range of compatible scanners can be used with the ZK830. One style, available through Avery Weigh-Tronix, is shown below.



## 8 Supervisor menu

This menu allows a supervisor to change those functions of an application that are configurable. Access the supervisor menu using the password 1793. Refer to [Accessing the menus on page 30](#) for instructions.



---

*Wherever there is an option to print information in the any of the supervisor's menus, the information will print out of Port 1 or Port 2, whichever is configured.*

---



---

*The menus are always explained in a sequential manner to cover all information in a logical fashion. You will probably never access all the menu items in this manner. You can navigate to the area of the menu that needs to be changed by using the navigation key chart shown with the menus.*

---

The Supervisor menu changes based on the active application. Go to the appropriate section.

- [General Weighing application supervisor menu on page 46](#)
- [Counting application supervisor menu on page 49](#)
- [Checkweighing application supervisor menu on page 53](#)



---

*Use the [Numeric entry procedure \(without optional keypad\) on page 16](#) or [Numeric entry procedure \(with optional keypad\) on page 16](#) when you need to enter values.*

---

## 8.1 General Weighing application supervisor menu

Figure 8.1 shows the Supervisor menu when you are in the General Weighing application.

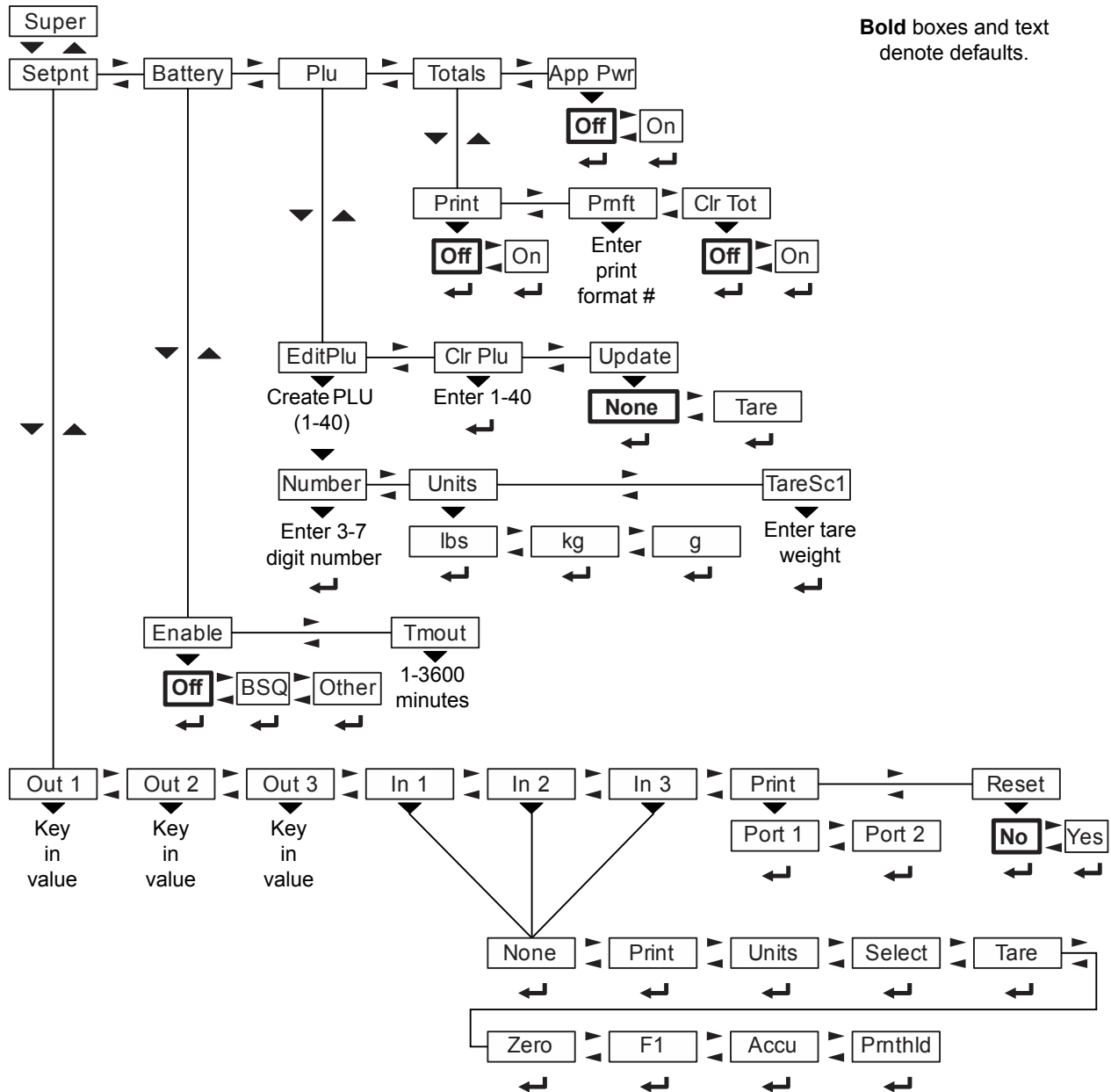

Figure 8.1 Supervisor menu for the General Weighing application



The Setpoint menu is the same for all the applications so will only be explained once here. Exceptions are noted in the text.

Use the navigation keys to reach the item you want to set. Each item is explained on the following pages.

### 8.1.1 Setpoint menu item

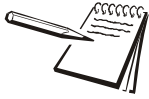

A setpoint value can be entered up to scale capacity.

Turn off or disable any setpoints you are not using. See the Service manual for information on disabling or turning off setpoints.

With the General Weighing application active, access the Supervisor menu. Refer to [Accessing the menus on page 30](#) for instructions. From **SuPEr**, press **SELECT** ...

**SEtPnt** is displayed. Use this to set the following parameters:

**outPutS** For each output, 1, 2, and 3, key in a weight value and accept it by pressing the **ENTER** key.

**inPutS** You can use this to assign any of the inputs listed in the submenu to input 1, input 2 or input 3. Press **ENTER** to accept the selection.

Default choice is **nonE**. The choices are listed in [Figure 8.1](#).

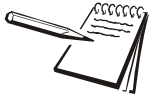

The remote input can be used to perform an accumulated print total function. Use the **PrintHoLd** function to simulate a “press and hold” of the **PRINT** key. If you are using a momentary switch, press and release. If you are using a toggle switch, switch it **ON** then **OFF** to reset the function for the next time.



Inputs and Outputs must be enabled **ON** in a separate password protected menu. Some input choices will not apply in the application that is active.

**Print** Use this to print the settings under **SEtPnt**. Choose which port to use.

**rESEt** Use this to reset the settings under **Edit** to factory defaults.

### 8.1.2 Battery menu item



The battery status and timeout features are for the internal battery option and do not function with other battery sources.

Use this to enable the battery and to set a timeout length (in minutes). If this time expires with no scale or keypad activity the indicator will automatically shut off.

**EnAbLE** Choose **bSq** or **otHEr** to enable battery usage. If you pick **otHEr**, setpoint #3 will be disabled. Choose off to disable battery usage.



Only enable the battery and set the **tMout** value if using the internal ZK830 battery option. The shut off timer will not work with other external battery sources.

**tMout** This stands for timeout. Use this to set the length of time before inactivity of the scale and keypad cause battery power to be shutoff. Values between 1 and 3600 minutes are valid.

### **8.1.3 PLU menu item**

---

Use this to create, edit or clear up to 40 part lookups.

**EditPLu** Enter a PLU number from 1-40.

**nuMbEr** Enter 3-7 digit identifier for this item or product.

**unitS** Choose the unit of measure for this PLU.

**tArE** Enter a tare weight for this PLU.

**cLr PLu** Enter the PLU number you wish to clear all information from and press **ENTER**.

**uPdAtE** If you have an active PLU, you can enable the user to update the tare weight or not.

For example, if you allow the user to update the tare weight, with an active PLU the user can get a new tare weight and press the **PLU** key once to view the current PLU number then quickly press the **PLU** key twice more to update the tare weight in the PLU.

### **8.1.4 Totals menu item**

---

This function must be enabled in a password protected menu. If enabled, during normal operation the user can press and hold **PRINT** for three seconds and the selected total print format will be sent out any port that is set up to print. The display will flash **Prn-tot**.

**Print** Turn the print function on or off for the totals.

**PrnFt** Choose the print format number for the printout.

**cLr tot** Enable or disable clearing the accumulated total after printing.

### **8.1.5 App Pwr menu item**

---

Enable this to force the user to pick the application desired at the next power up.

This completes the Supervisor menu for General Weighing. Repeatedly press **TARE** until the indicator returns to normal weighing mode.



---

*The changes are saved automatically and the indicator reboots.*

---

The current weight value is displayed.



## 8.2 Counting application supervisor menu

Figure 8.2 shows the Supervisor menu when you are in the Counting application:

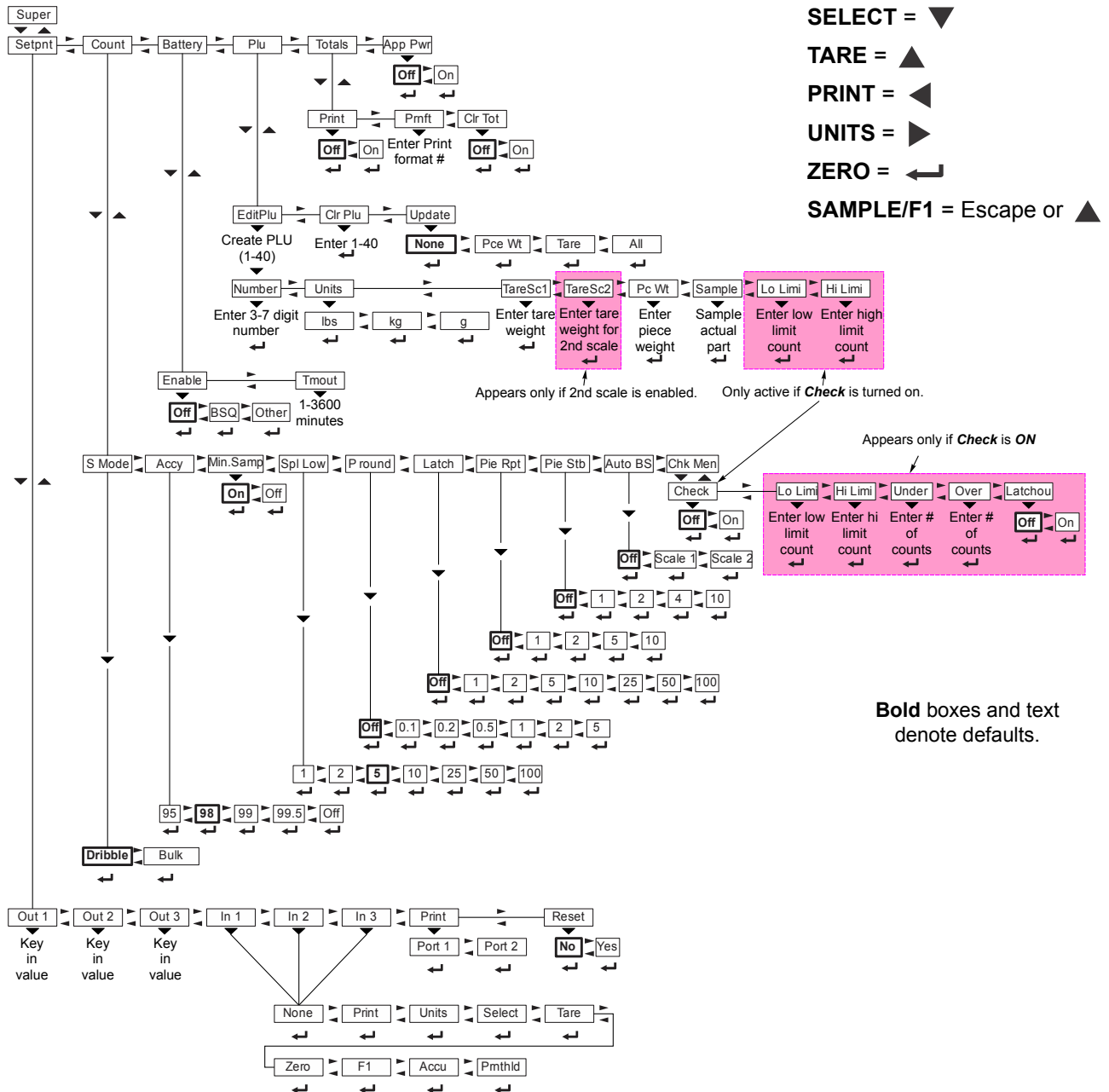

Figure 8.2 Supervisor menu for the Count application

Follow these steps to set the items in the Supervisor menu.



The **Setpnt**, **bAttErY**, **totALS** and **APP Pwr** submenus in Figure 8.2 are the same as described in [General Weighing application supervisor menu on page 46](#). Go there for information on those submenus. The **Count** and **PLU** submenus are described below.

## 8.2.1 Count menu item

With the Count application active, access the Supervisor menu using password 1793. Refer to [Accessing the menus on page 30](#) for instructions. Use the navigation keys to display the item you want to set. Each are described on the following pages.

**S ModE** Choose the type of sampling you want to use; bulk or dribble.

Bulk sampling is an automated sampling method. You place all the items to be sampled on the scale at the same time and the scale will automatically calculate and display the count.

Dribble sampling requires one more step than bulk sampling. You can count the items to be sampled onto the scale and then press the **SAMPLE** key to begin the piece weight calculation. This can be handy if the items are more easily counted onto the scale one at a time versus all at once.

**AccY** This stands for Accuracy. Choose the minimum desired sample accuracy. Reducing sample accuracy allows the scale to function in more disruptive environments. Choices: Off, 95%, 98%, 99% or 99.5%.

For the end user, choosing a higher accuracy may cause the scale to time-out in a disruptive environment or possibly slower display of the count. Increase the sample weight to more than the minimum to maintain accuracy at lower accuracy settings in less stable environments.

**Min.SAmP** If you want to count very small parts and the environment is such that the scale is unable to get a sample weight that meets your accuracy requirement, you can turn this requirement off. This will allow the ZK830 to successfully get a sample weight. This may be done at the expense of your requested accuracy.

If enabled you must have a sample size of 0.01% of capacity in dribble mode or 0.02% of capacity for bulk mode. Choices: **on, off**.

**SPL LoW** Stands for Sample Low. Use this to choose the minimum allowable sample size when you press the **SAMPLE** key. Choices: **1, 2, 5, 10, 25, 50, 100**. Example: If you pick 5, Add 5 is displayed as the minimum sample size when you begin the sampling process.

**P round** This stands for Piece Weight Rounding. This forces a rounding of the piece weight obtained using the percentage factors listed below in the choices. This can make counts more repeatable and predictable.

Choices: **off, 0.1, 0.2, 0.5, 1, 2, or 5**. The higher the percentage picked, the more the piece weight is rounded and the more repeatable and predictable the counts. This may also mean less accurate counts.

**LAtcH** If enabled the count must change by a selected amount before the display changes. Choices: **off, 1, 2, 5, 10, 25, 50, 100**.



---

*If there is motion the latch will disengage.*

---

- PiE rPt** Stands for Piece Count Repeat. This causes the scale to remember the last display weight and count. If the next weightment is the same weight or within the number of divisions selected, the last displayed count will be repeated. Choices: **OFF**, **1**, **2**, **5** or **10**.
- PiE Stb** Stands for Piece Weight Stabilization. This causes the scale to compare a newly calculated piece weight with the existing piece weight. If the new piece weight is within the selected percentage of the existing piece weight, the scale will continue to use the existing piece weight. Choices: **OFF**, **1**, **2**, **4** or **10**.
- Auto bS** Stands for Automatic Base Switching: (You must have selected and configured a remote base for this function to work.) Choose to enable or disable auto base switching mode. Auto base switching lets you perform sampling on one of the bases. When **ScALE 1** is selected, sampling is performed on the local BSQ base. If **ScALE 2** is selected, sampling is performed on the remote base. Choices: **OFF**, **ScALE 1**, **ScALE 2**.
- cHK MEn** This stands for Check Menu. Use this to enable or disable check counting (like checkweighing except counts are used instead of weight). If you enable this function these menu items appear:
- Lo LiMi** This stands for Low Limit. Enter the lowest acceptable count.
- Hi LiMi** This stands for High Limit. Enter the highest acceptable count.
- ovEr** This stands for Over count. Enter the number of counts which will be equal to each over segment of the bargraph.
- undEr** This stands for Under count. Enter the number of counts which will be equal to each under segment of the bargraph.
- LAtchou** This stands for Latch Output. If **On**, once a count is stable a tripped output will not change until the scale returns to gross zero. **OFF** disables this function.

### **8.2.2 PLU menu item**

Use this to create, edit or clear up to 40 part lookups.

- EditPLu** Enter a PLU number from 1-40.
- nuMbEr** Enter a 3 to 7 digit identifier for this item or product.
- unitS** Choose the unit of measure for this PLU.
- tArESc1** Enter a tare weight for this PLU on scale 1. If a second scale is enabled, **tArESc2** will appear and you can enter a tare for this scale.
- Pc Wt** Enter a piece weight value for this PLU.
- SAMPLE** Use to sample parts for this PLU. This will update the **Pc Wt** value mentioned above.
- Lo LiMi** Enter a low limit count. Only active if **chEcK** is enabled under **cHK MEn**.
- hi LiMi** Enter a high limit count. Only active if **chEcK** is enabled under **cHK MEn**.

**cLr PLU** Enter the PLU number you wish to clear all information from and press **ENTER**.

**uPdAtE** If you have an active PLU, you can enable the user to update the piece weight or the tare weight or both or none.

For example, if you allow the user to update the piece weight, with an active PLU the user can take a new sample, get a new piece weight and press the **PLU** key once to view the current PLU number then quickly press the **PLU** key twice more to update the piece weight in the PLU. The same process is used to update the tare value if you enable it in this menu. Choose **ALL** to allow updating both and **nonE** to deny this ability.

This completes the Supervisor menu for the Count application. Repeatedly press **TARE** until the indicator returns to normal weighing mode.

## 8.3 Checkweighing application supervisor menu

Figure 8.3 shows the Supervisor menu when you are in the Checkweighing application:

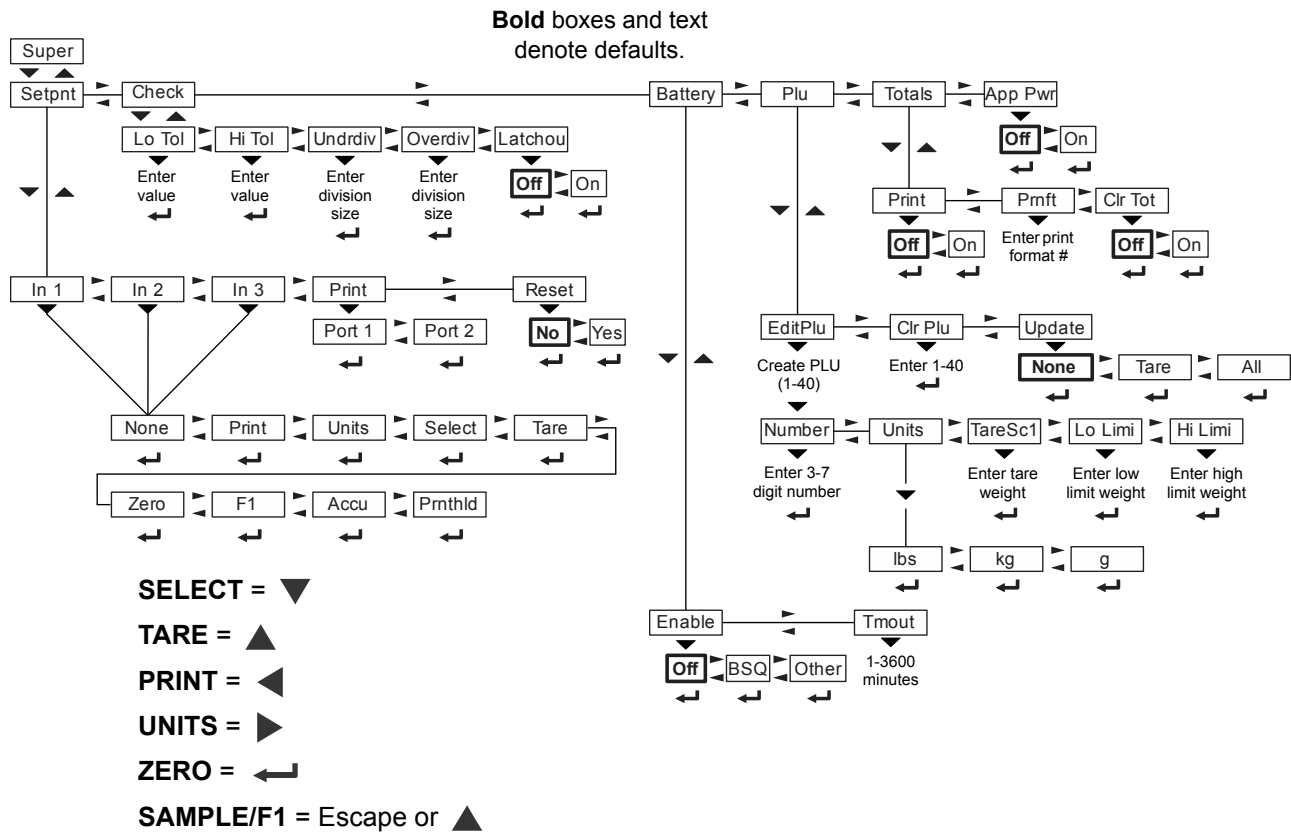

Figure 8.3 Supervisor menu for the Checkweighing application

Follow these steps to set the items in the Supervisor menu.



All the submenus in Figure 8.3, except for the **chEcK** and **PLU** menus, are the same as described in [General Weighing application supervisor menu on page 46](#). Go there for information on those submenus. The **chEcK** and **PLU** submenus are described below.

### 8.3.1 Check menu item

1. With the Checkweighing application active, access the Supervisor menu using password 1793. Refer to [Accessing the menus on page 30](#) for instructions. The items relating to checkweighing are described on the following pages.

**Lo toL** This stands for Low Tolerance. Enter a weight value for the weight tolerance below the target weight.

**Hi toL** This stands for High Tolerance. Enter a weight value for the weight tolerance above the target weight.

**undrdiv** This stands for Under Divisions. Enter the number of divisions below your low tolerance which will cause the first under segment to appear.

**ovErdiv** This stands for Over Divisions. Enter the number of divisions above your high tolerance which will cause the first over segment to appear.

**Example to illustrate how Lo Tol, Hi Tol, Undrdiv and Overdiv relate:**

Target is 100 lb at a division size of 0.1 lb

Low tolerance 10 lb

High tolerance is 20lb

Under division is 1

Over division is 2

So the acceptable range is 90 – 120 lb

At 89.9, one under segment illuminates

At 89.8, two under segments illuminate

Below 89.7, three under segments would be shown

At 120.2, one over segment illuminates

At 120.4, two over segments illuminate

**LAtcHou** This stands for Latch Output. If **On**, once a weight is stable a tripped output will not change until the scale returns to gross zero. **oFF** disables this function. **oFF** is the default.

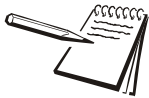

---

With **LAtcHou oFF**, the Under, Accept or Over outputs will be activated using live weight.

With **LAtcHou on**, the weight has to stabilize before the annunciator and output for the appropriate condition (Under, Accept or Over) are activated.

---

This completes the Supervisor menu for the Checkweighing application. Repeatedly press **TARE** until the indicator returns to normal weighing mode.



# Avery Weigh-Tronix



## **Avery Weigh-Tronix USA**

1000 Armstrong Dr.

Fairmont MN 56031 USA

Tel: 507-238-4461

Fax: 507-238-4195

Email: [usinfo@awtxglobal.com](mailto:usinfo@awtxglobal.com)

[www.averyweigh-tronix.com](http://www.averyweigh-tronix.com)

## **Avery Weigh-Tronix UK**

Foundry Lane,

Smethwick, West Midlands,

England B66 2LP

Tel: +44 (0) 8453 66 77 88

Fax: +44 (0)121 224 8183

Email: [info@awtxglobal.com](mailto:info@awtxglobal.com)

[www.averyweigh-tronix.com](http://www.averyweigh-tronix.com)